

2304

1

	x1
	x1
	x1
	x1
	x1



2 1+

	x1
	x1
	x1
	x1
	x1
	x1
	x1
	x1
	x1
	x1
	x1

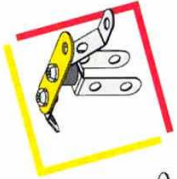

3 2+

	x1
	x1
	x1
	x1
	x1
	x1
	x1
	x1
	x1
	x1
	x1

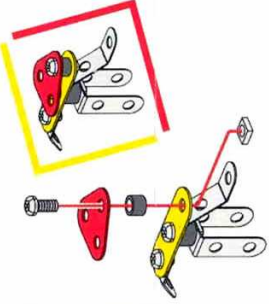

4

	x1
	x1
	x1
	x1
	x1
	x1
	x1
	x1
	x1
	x1
	x1

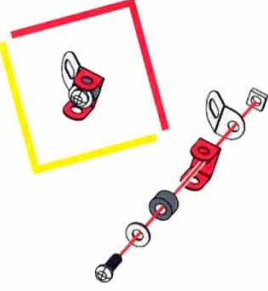

5 3+ 4+

	x1
	x1
	x1
	x1
	x1
	x1
	x1
	x1
	x1
	x1
	x1

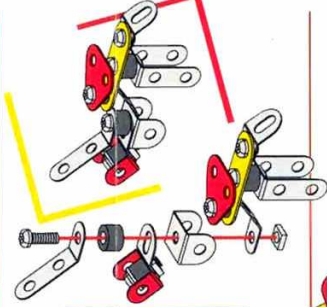

6 5+

	x1
	x1
	x1
	x1
	x1
	x1
	x1
	x1
	x1
	x1
	x1

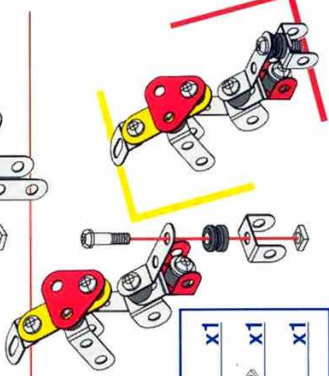

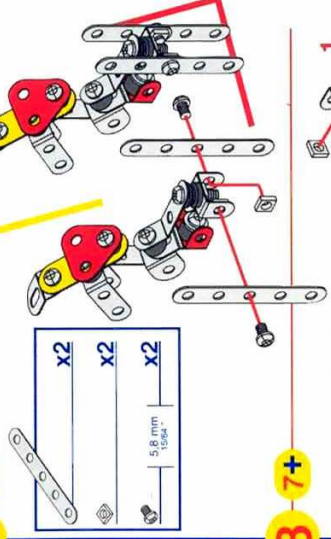
7 6+

	x2
	x2
	x2

5,8 mm
1/8"

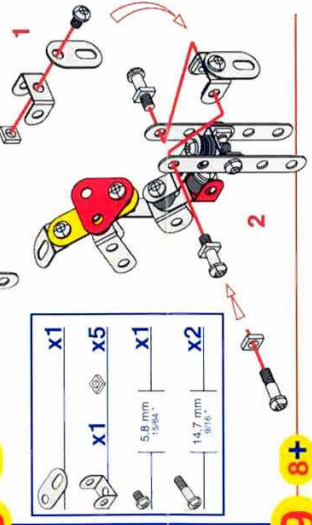
8 7+

	x1
	x5
	x1
	x2

5,8 mm
1/8"

14,7 mm
3/8"

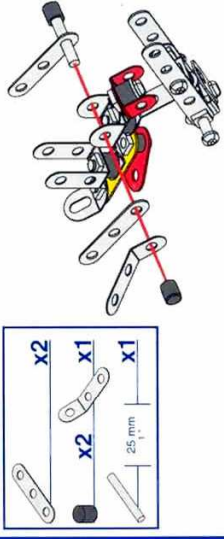
9 8+

	x2
	x1
	x1

25 mm
1"

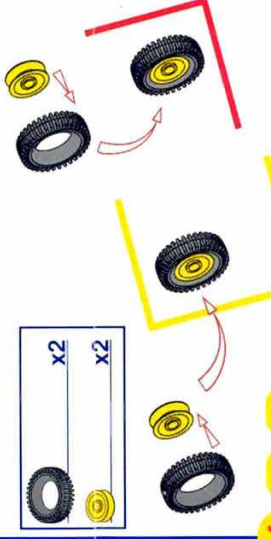
10

	x2
	x2

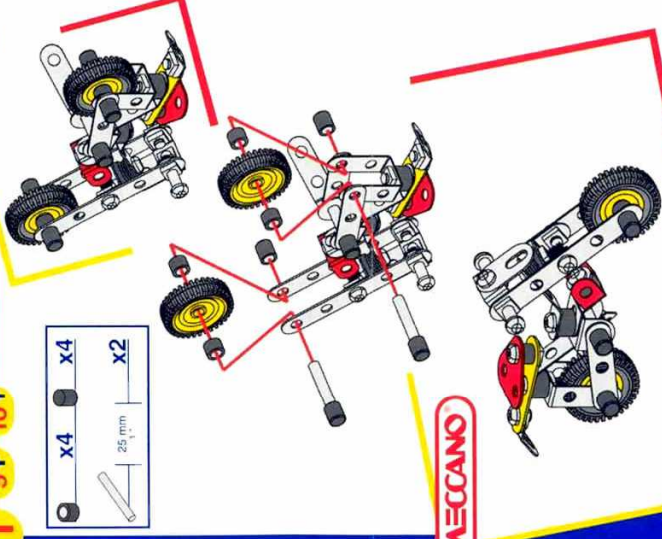
11 9+ 10+

	x4
	x4
	x2

25 mm
1"

MECCANO

MECCANO è un marchio registrato della Meccano S.p.A. - Santeramo Colle, Italia. **MECCANO** è un marchio registrato della Meccano S.p.A. - Santeramo Colle, Italia. **MECCANO** è un marchio registrato della Meccano S.p.A. - Santeramo Colle, Italia. **MECCANO** è un marchio registrato della Meccano S.p.A. - Santeramo Colle, Italia.

MECCANO S.p.A. - Santeramo Colle - Italy
 MECCANO S.p.A. - Santeramo Colle - Italy
 MECCANO S.p.A. - Santeramo Colle - Italy
 MECCANO S.p.A. - Santeramo Colle - Italy